

2023

SLX 260 OUTBOARD



Sea Ray 

BORN TO SHINE

The SLX™ 260 Outboard combines ingenuity with intuition to reveal a host of next-level features that make boating effortless. Everything aboard has been carefully considered in response to feedback from boaters. Seating has been improved for a smoother, more luxurious ride. Integrated storage keeps gear, watersports equipment and other items secure and within reach. The expanded transom sunpad presents a relaxing space to take in the sights along the water's edge. Leveraging sophisticated style and easy-to-use amenities, the SLX 260 Outboard truly shines in delivering an escape from the day-to-day.





2023 SLX 260 OUTBOARD

Sea Ray

STANDARD SPECIFICATIONS



STANDARD PROPULSION

Mercury® 300 Verado® Outboard
(300 hp / 224 kW) – black



CRUISING SPEED

30–32 mph / 48–51 kph



WIDE OPEN THROTTLE (WOT)

51–53 mph / 82–85 kph



FUEL CAPACITY

75 gal / 284 L



RANGE

192 mi / 309 km (cruising speed)
145 mi / 233 km (WOT)



LENGTH OVERALL

28'7" / 8.71 m with outboard
30'0" / 9.14 m with outboard & anchor



BEAM

8'6" / 2.59 m



BRIDGE CLEARANCE

5'3" / 1.60 m without tower
8'5" / 2.57 m with tower



DRAFT

34" / 86 cm (outboard down)
19" / 48 cm (outboard up)



DRY WEIGHT

5,564 lb / 2,524 kg



WATER READY WEIGHT

7,020 lb / 3,184 kg (fully optioned)



DEADRISE

21°



WATER CAPACITY

14 gal / 53 L



HOLDING TANK

6 gal / 23 L



CAPACITY

15 people / 2,190 lb / 993 kg
Maximum: 3,210 lb / 1,456 kg



1) Speed determined by GPS. Fuel consumption based on total usage by engines. MPG computed from MPH and GPH. Range based on 90% of total fuel capacity.
2) The performance data shown is valid only for the specific boat tested and the conditions that existed when the test was performed. Many factors may affect performance, including but not limited to, installation of certain options; vessel loading and trim; weather and sea conditions; and engine, propeller, and hull bottom conditions. Sea Ray makes no performance guarantees.

AT A GLANCE

A POWER TOWER T-TOP
The boat is available with a next-generation Power Tower featuring removable canvas sections that can be unzipped to reveal a T-top opening.

B DELUXE COCKPIT
The cockpit showcases an updated layout with deeper ergonomic seating for a smoother ride.

C REIMAGINED WINDSHIELD
For a more enjoyable cruising experience, the windshield has been redesigned to be angled level with the horizon when the boat is planing.

D PORT-SIDE COMPARTMENT
The convenient port-side compartment can be used to store gear or upgraded to a head for uninterrupted boating.

E PLUSH BOW SEATING
The bow offers lounge-style seating with foldable armrests. Choose the Comfort Bundle to add a teak table and filler cushion.

F BOW UPGRADES
With the Anchor Bundle, the bow can be enhanced with a stainless steel anchor, windlass, rope and chain.

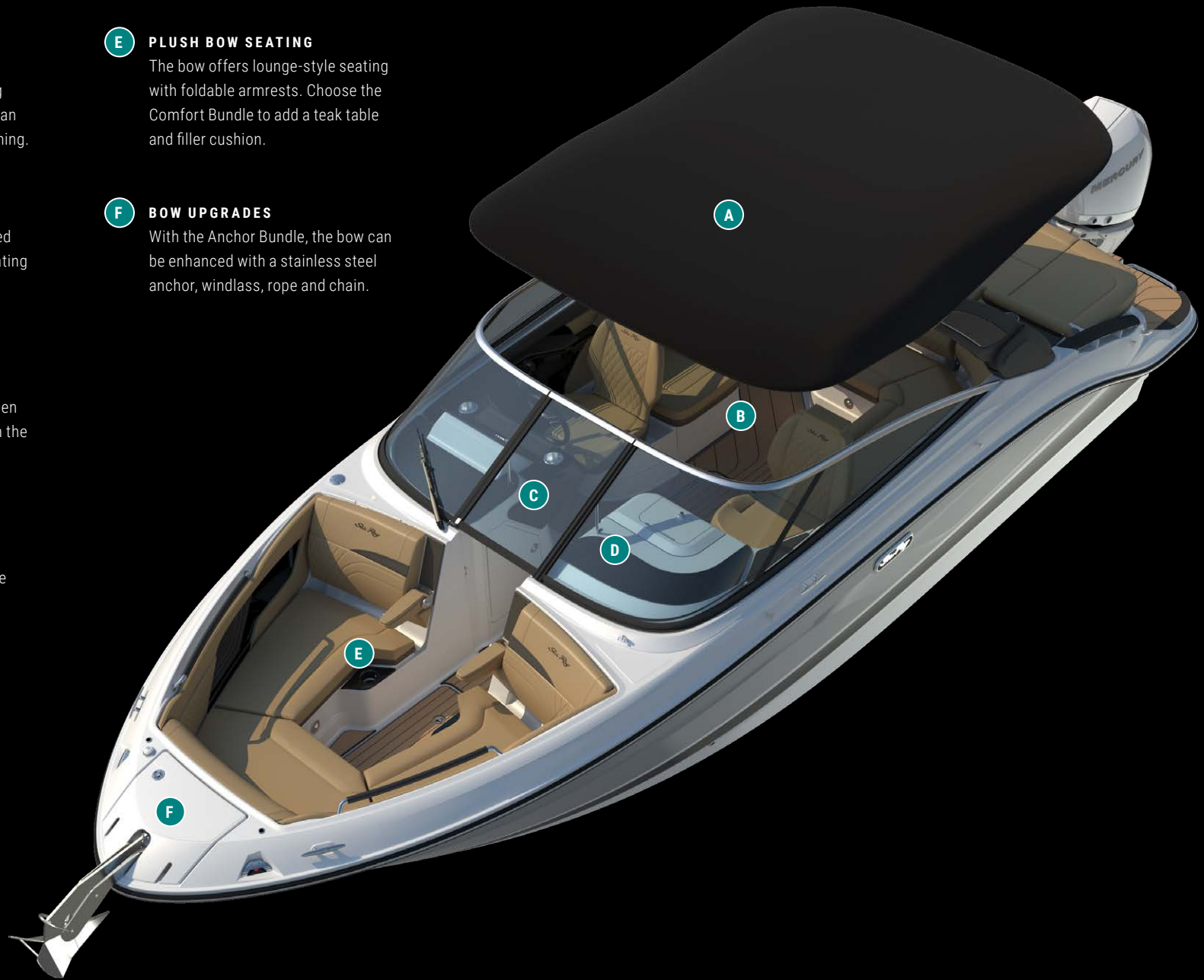

AT A GLANCE

A SEAMLESS CONTROL
The helm is equipped with a Dual Digital Dash™ for effortless captaining, including 9" Simrad® touchscreen displays with Mercury® VesselView® Mobile.

B FUSION® AUDIO
Listen to music out on the water with premium sound from the Fusion® stereo or select the Entertainment Bundle for a Fusion® Premier audio system.

C VERSATILE SUNPAD
The expanded sunpad presents an inviting place to relax. A space under the sunpad can be filled with drinks for an integrated cooler or kept empty for dry storage.

D OPTIMIZED STORAGE
Integrated storage optimized for space has been incorporated throughout the boat. A storage area under the sunpad is ideal for stowing floating water mats and inflatables.

E POWERFUL PROPULSION
The boat features a standard Mercury® 300 Verado® outboard engine with SmartCraft® Digital Throttle & Shift (DTS) and optional Dynamic Running Surface™.

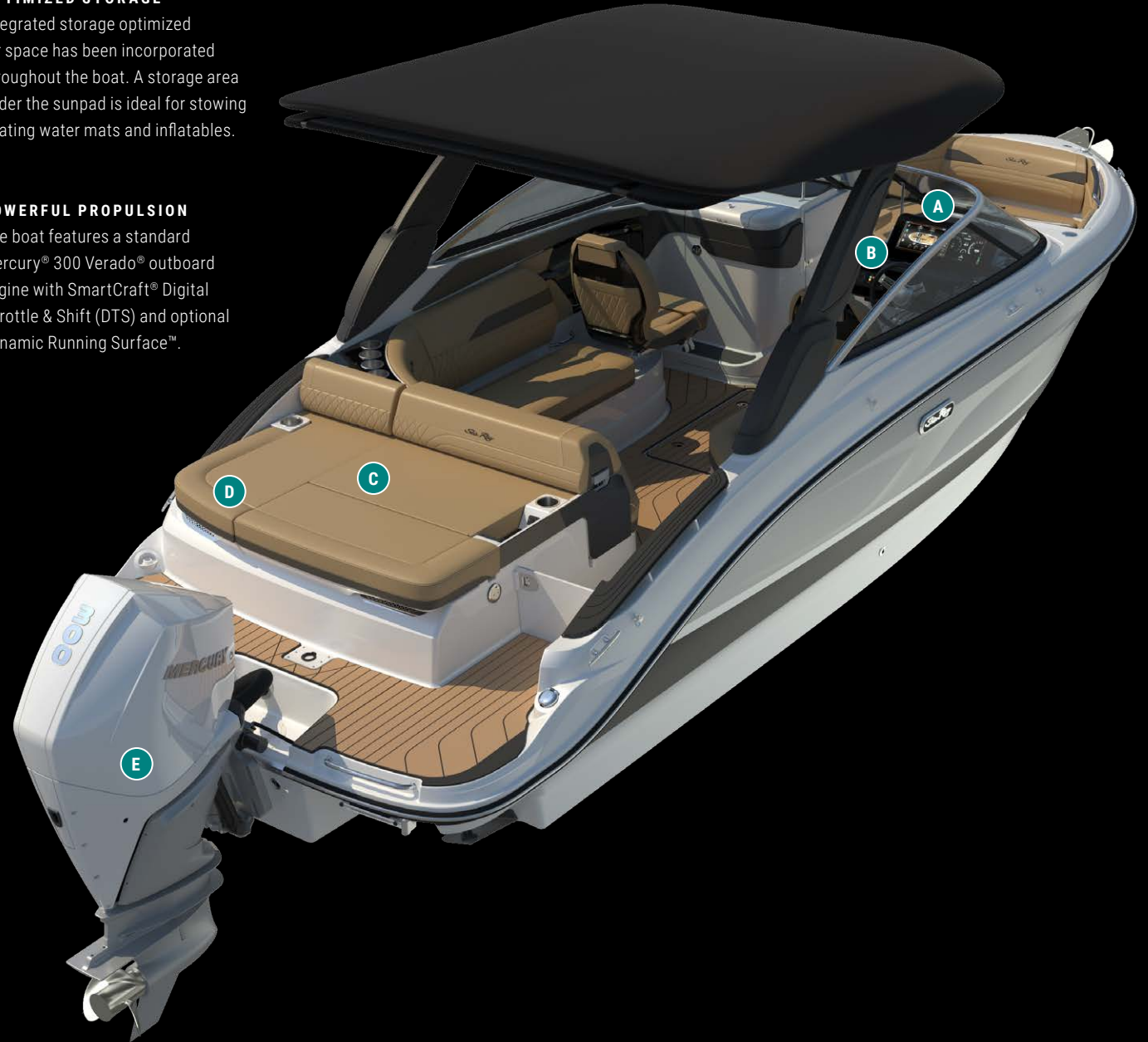



2023 SLX 260 OUTBOARD

Sea Ray®



COLORS & MATERIALS

EXTERIOR COLOR SCHEMES

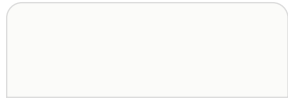

Arctic White (standard)



Onyx Black



Horizon



Sea Ray Blue



Quantum Blue



Kingfisher Teal



Neo Mint Green



Rally Red



FULL HULL



HULL SIDE

Hull bottom available in Arctic White or Onyx Black only



THREE ZONE HULL



BOOT STRIPE

Available with full hull or hull side color schemes only

VINYL UPHOLSTERY COLORS



Ivory (standard)
White base with brown accents



Dune
Tan base with brown accents



Stone
Gray base with dark gray accents

CANVAS



Sunbrella® Black

BOW & COCKPIT FLOORING

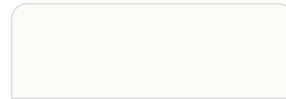

Non-skid fiberglass (standard)



SeaDek® – Dune



SeaDek® – Moonrock



Infinity woven vinyl – Brown



Infinity woven vinyl – Gray

SWIM PLATFORM FLOORING

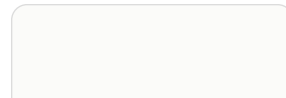

Non-skid fiberglass (standard)



SeaDek® – Dune



SeaDek® – Moonrock

STANDARD FEATURES

BOW & COCKPIT

- Cup holders, stainless steel (17)
- Floor liner, fiberglass (self-bailing)
- Lighting, LED (courtesy)
- Outlets, 12V accessory (helm & transom) – 2
- Outlets, USB dual port (5)

DOORS

- Bow block-off door, acrylic
- Hatch for bilge access, gas-assisted
- Transom door, acrylic

SEATING

- Aft L-shaped bench seating with storage below
- Bow seating, U-shaped with foldable armrests & hinged cushions
- Cockpit social area with opposing seating & storage
- Helm bucket seat with swivel, slider & flip-up bolster
- Port companion bucket seat with swivel, slider & flip-up bolster
- Sunpad

STORAGE

- Bow storage (in floor & under seating)
- Cooler storage (cockpit)
- Side panel tubs (cockpit)
- Ski & wakeboard storage, gas-assisted (cockpit floor)

HULL & DECK

- Bow rail, vinyl-wrapped stainless steel
- Cleats, stainless steel through-bolted (8") – 6
- Deck fill plate, stainless steel
- Drain plug
- Eyes, stainless steel (bow & stern)
- Handrails, stainless steel
- Light, removable (stern)
- Lights, navigation (stainless steel) – integrated into deck
- Rub rail, PVC with stainless steel insert
- Swim platform, integral with concealed stainless steel four-step swim ladder & grab handles
- Thru-hull fittings, stainless steel
- Windshield, tempered tinted curved glass with walk-through door & stainless steel header

STORAGE

- Anchor storage
- Glove box (port console door)
- Integrated cooler or dry storage, fiberglass (under sunpad)
- Storage (transom walkway floor)
- Storage with lockable door (under port console)
- Transom storage for gear & inflatables with gas-assisted fiberglass lid (under sunpad)

TECHNICAL

ELECTRICAL

- Battery charger, 12V onboard (triple bank)
- Electrical system, 120V 60Hz
- Fuse block
- Remote battery switches

FUSION® AUDIO SYSTEM

- AM/FM stereo (helm)
- Bluetooth™
- Digital Signal Processing (DSP)
- Wi-Fi audio streaming with Apple AirPlay® 2
- XS Series speakers (6.5") – 2 pairs

HELM

- Digital Dash™, dual (9")
- Active Trim control & monitoring
- Chartplotter with preloaded charts (North America only)
- CZone® digital switching
- Mercury Marine® VesselView® Link
- Simrad® 9" touchscreen displays (2)
- Transducer with depth, water temperature & fishfinder
- Horn
- Mercury Marine® SmartCraft® Digital Throttle & Shift (DTS)
- Active Trim speed-based automatic engine trim system with integrated GPS
- Engine start / stop
- Mercury Marine® VesselView® Mobile
- Parallel start system
- Steering, power-assisted with tilt wheel
- Switch panel with illuminated weatherproof chrome switches
- Tilt & trim, power

MECHANICAL

BILGE

- Bilge lighting, 12V
- Bilge pump, 1200 GPH 12V automatic (aft)
- Bilge storage, finished (aft)
- Vents, integral

FUEL SYSTEM

- Evaporative emissions fuel system
- Fuel lines, USCG compliant
- Fuel tank with anti-siphon valve & electric sending unit

UNDERWATER GEAR

- Propellers, stainless steel

OPTIONS & ACCESSORIES

PROPULSION

- Mercury® 300 Verado® Outboard (300 hp / 224 kW) – white

BOW & COCKPIT

- Boarding ladder, stainless steel concealable four-step with hatch (bow)
- Flooring, Infinity Luxury Woven Vinyl™ (snap-in)
- Flooring, SeaDek®
- Side entry step (starboard cockpit)

HULL & DECK

- Air compressor for water toys with dedicated storage
- PTM Watersports Premium ski mirror
- Ski tow pylon, removable
- Windshield wiper (starboard)

TOPS & CANVAS

- Bimini top & boot with stainless steel ball & socket
- Mooring cover – black
- Power Tower with removable canvas T-top & automated extended sunshade
- Sunshade, manual with poles (bow seating)
- Wakeboard racks, three-position swivel

TECHNICAL

ELECTRONICS

- 1st Mate™ Marine Safety & Security System
- Fusion® tower speakers (only available with tower option & Entertainment Bundle)
 - Apollo™ Series monoblock amplifier for subwoofer (2000W)
 - Signature Series can speakers (8.8") – 2

MECHANICAL

BILGE

- Storage caddy

UNDERWATER GEAR

- Dynamic Running Surface™ (trim tabs that automatically optimize running attitude & trim, delivering stability & performance)
- Propellers, high-altitude
- Trim tabs, electric with indicator

WASTE SYSTEM

Options require Water System Bundle.

- Gray water system
- Macerator with seacock interlock system
- Pump-out head with sink & holding tank
- VacuFlush® head with sink & direct overboard discharge(international only)
- VacuFlush® head with sink & holding tank

TRAILERS

- Trailer brakes, electric over hydraulic
- Trailer, galvanized tandem axle with bunks & tandem axle disc brakes
- Trailer, painted tandem axle with bunks & tandem axle disc brakes

INTERNATIONAL SYSTEMS

- CE certification
Some features and options may not be available when a boat is built for regions outside North America and/or has CE certification. Boats ordered with 220V 50Hz electrical systems will have the appropriate appliances in the corresponding voltage.

BUNDLES

ANCHOR BUNDLE

- Anchor, stainless steel
- Windlass with rope & chain

COMFORT BUNDLE

- Filler cushion (bow)
- Table with dedicated storage, teak (bow)
- Table with dedicated storage, teak (cockpit)

ENTERTAINMENT BUNDLE

ELECTRONICS

- Inductive charging station

FUSION® PREMIER AUDIO SYSTEM UPGRADE

- Apollo™ RA770 AM/FM stereo (helm)
 - Apollo™ Series amplifier, 8-channel (2400W)
 - Bluetooth™
 - Digital Signal Processing (DSP)
 - NRX300 remote unit (transom)
 - Signature Series speakers (7") – 3 pairs
 - Signature Series subwoofer (10")
 - Wi-Fi audio streaming with Apple AirPlay® 2

ESSENTIALS BUNDLE

- Cockpit & tonneau covers
- Fender clips, quick connect (6)
- Flagpole with base & U.S. flag
- Swim platform & port console storage flooring, SeaDek® (glue-down)

LIGHTING BUNDLE

- LED RGB-W color-changing & white accent lighting package
 - Lighting for bow & cockpit
 - Lighting for cup holders
 - Underwater thru-hull (2 lights)
- Lights, docking
- Sea Ray badge, illuminated (hull)
- Sea Ray logo light projected onto cockpit floor (only available with Power Tower option)

WATER SYSTEM BUNDLE

- Bow washdown
- Pullout sprayer (transom)
- Water pressure system with 12V pump & filtration

ANCHOR BUNDLE

Ensure your Sea Ray is secured wherever adventure takes you with factory-assembled features that make anchoring easy.



Stainless steel anchor

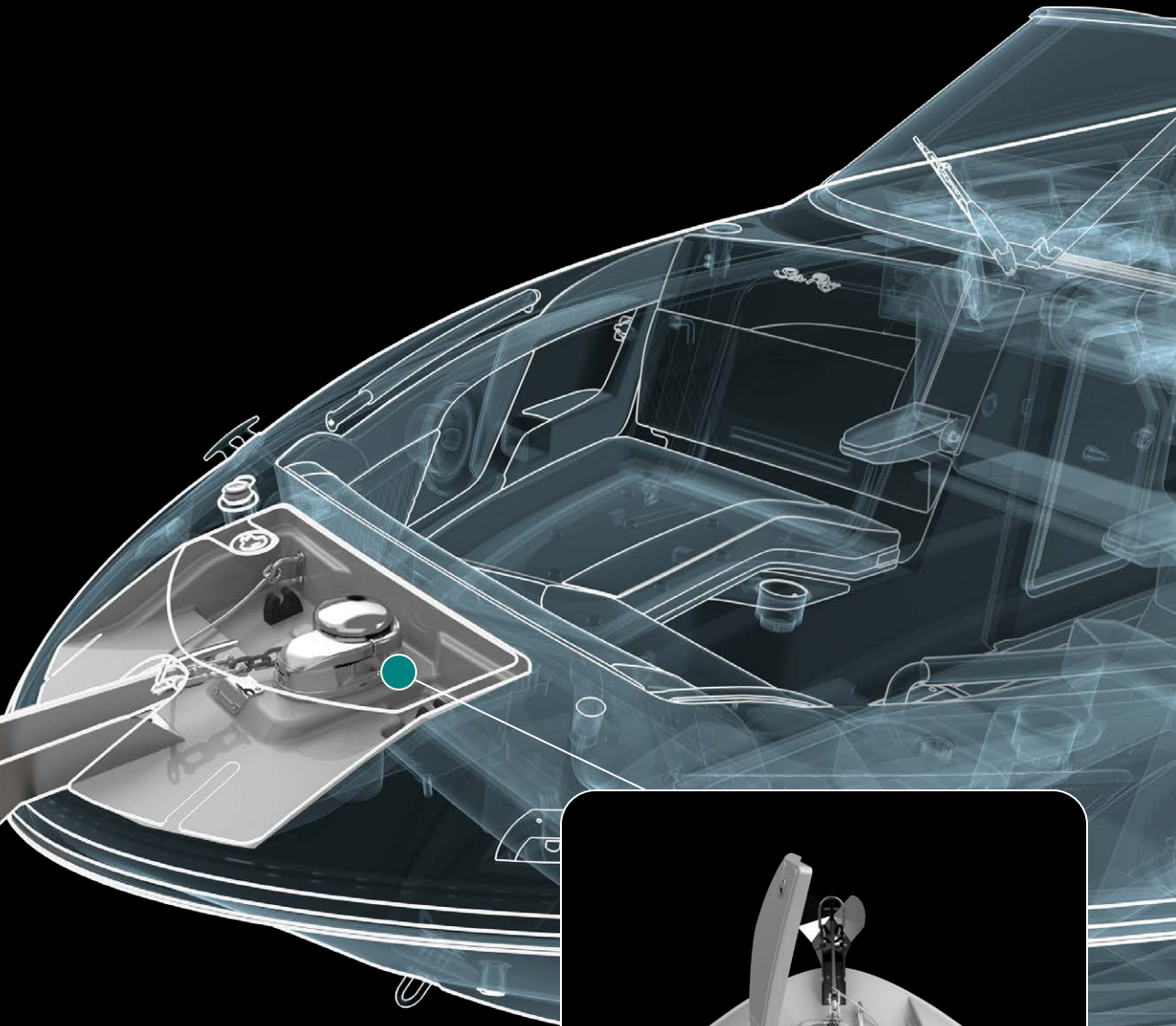
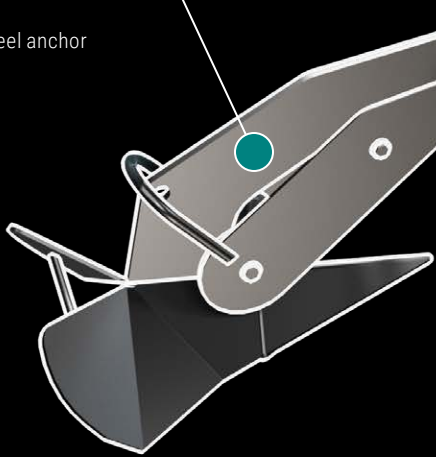

Windlass with rope and chain

COMFORT BUNDLE

Add a touch of luxury to your Sea Ray with stowable teak tables and a filler cushion that converts the bow into an expansive sunpad.

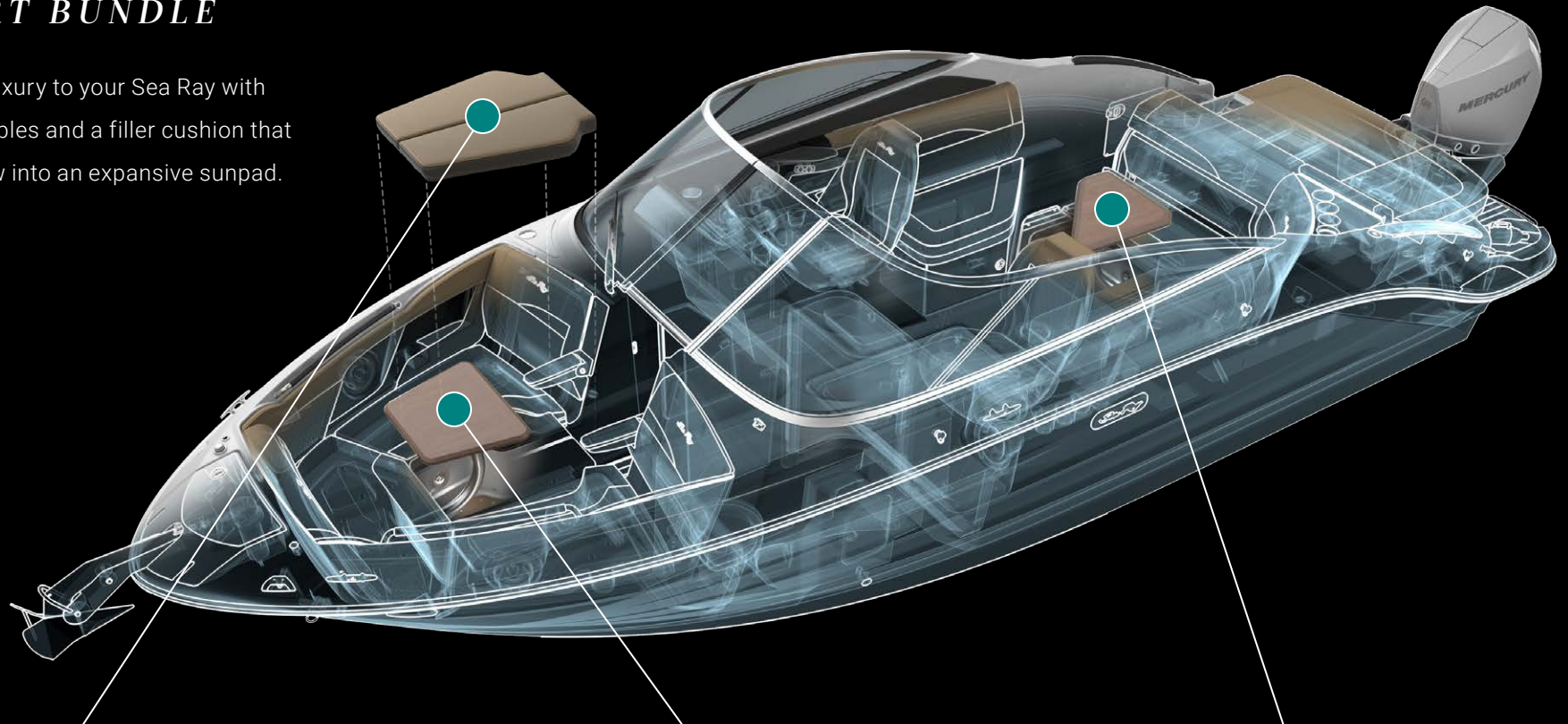

Bow filler cushion



Teak bow table



Teak cockpit table

ENTERTAINMENT BUNDLE

Keep the fun going all day long with an inductive charging station and the next level in marine audio entertainment from Fusion®.

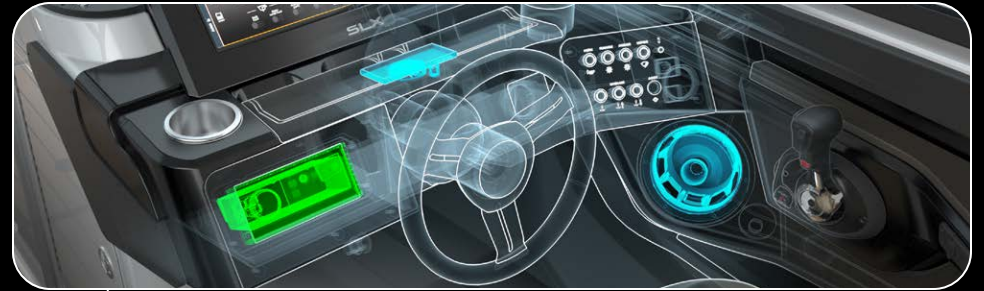

Fusion® Premier Audio system with Apollo™ RA770 stereo and inductive charging station

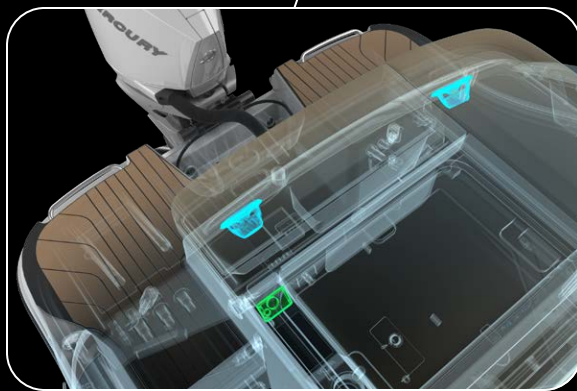
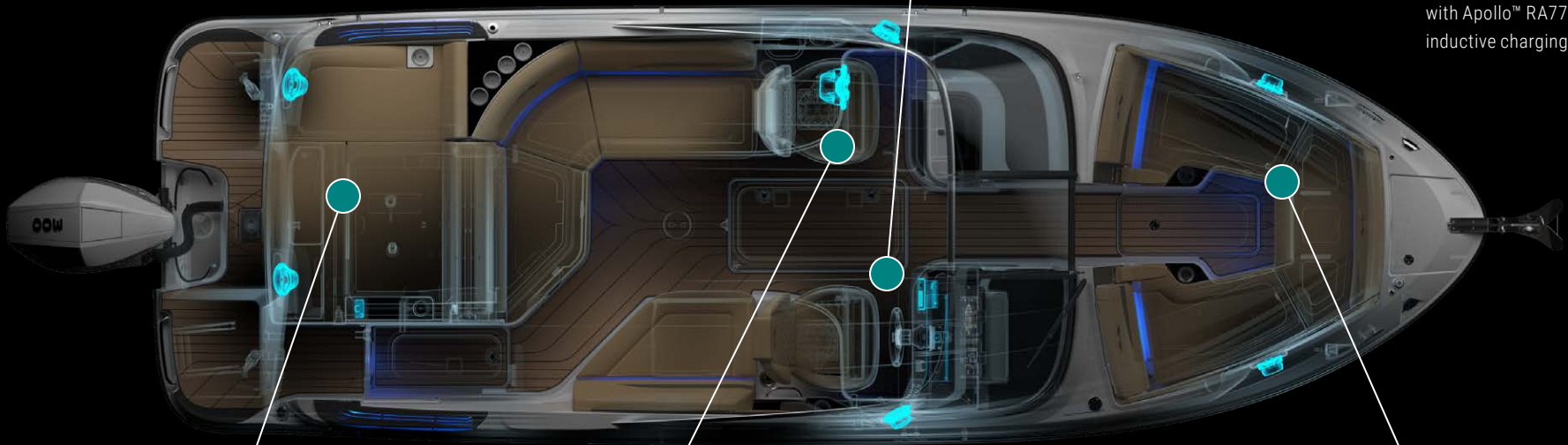

NRX300 remote unit and Signature Series speakers

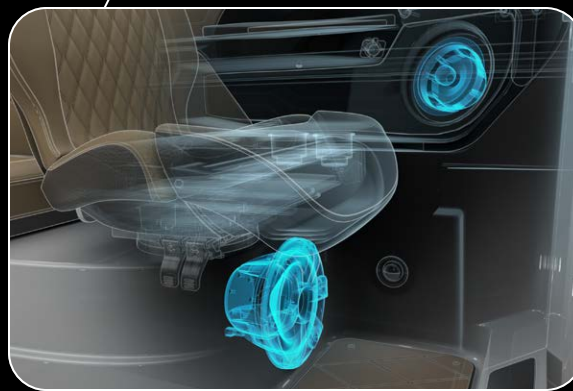

Signature Series subwoofer and speaker

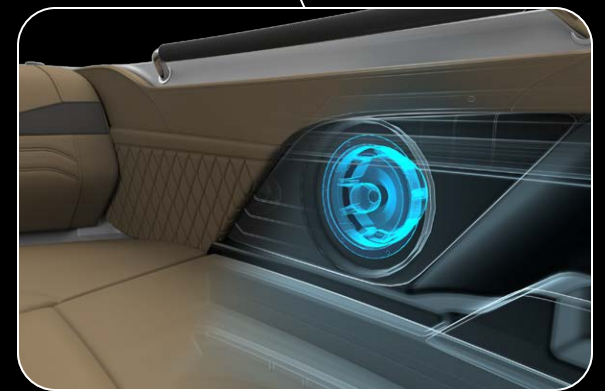

Signature Series bow speaker

ESSENTIALS BUNDLE

For a superior boating experience, elevate your Sea Ray with some of the most popular accessories requested by boaters.

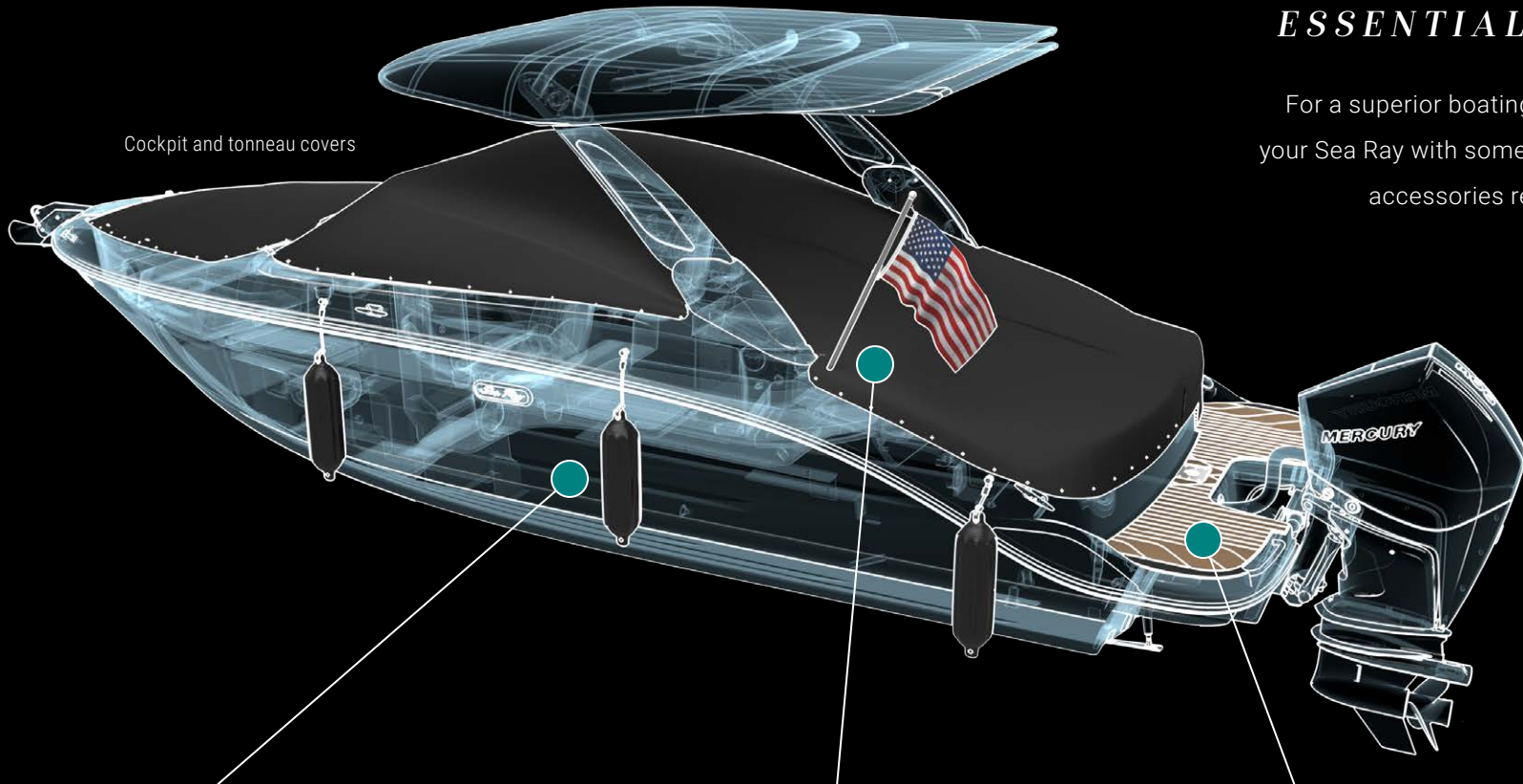

Cockpit and tonneau covers



Quick connect fender clips



Flagpole with base and U.S. flag



SeaDek® swim platform flooring

LIGHTING BUNDLE

Transition from day to night during a sunset cruise or twilight excursion with illuminating features that enhance the ambience.



LED RGB-W color-changing and white accent lighting package



Illuminated Sea Ray badge



Docking lights

WATER SYSTEM BUNDLE

Rinse sand from your Sea Ray and gear while out on the water with a convenient bow washdown and transom sprayer.

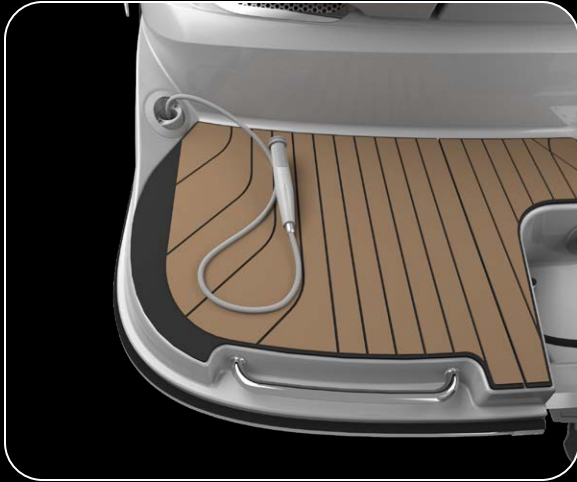

Transom pullout sprayer

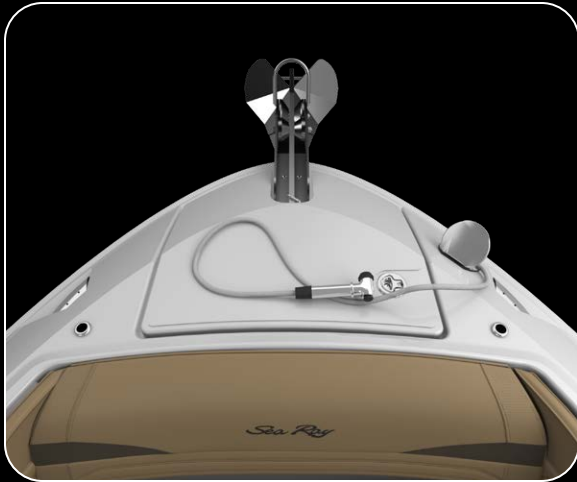

Bow washdown

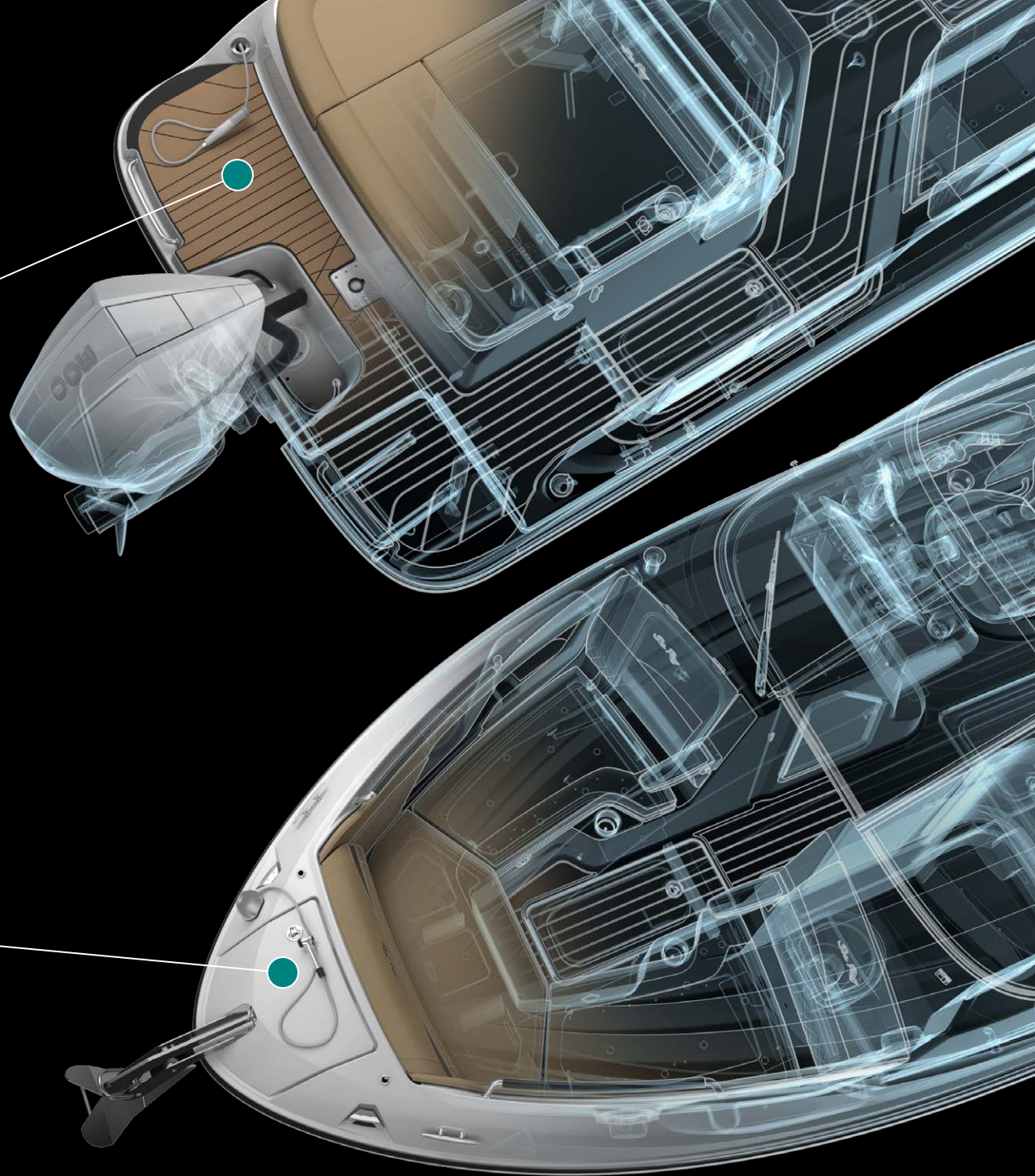

LAYOUT



DECK / COCKPIT

CENTER OF GRAVITY & TECHNICAL MEASUREMENTS

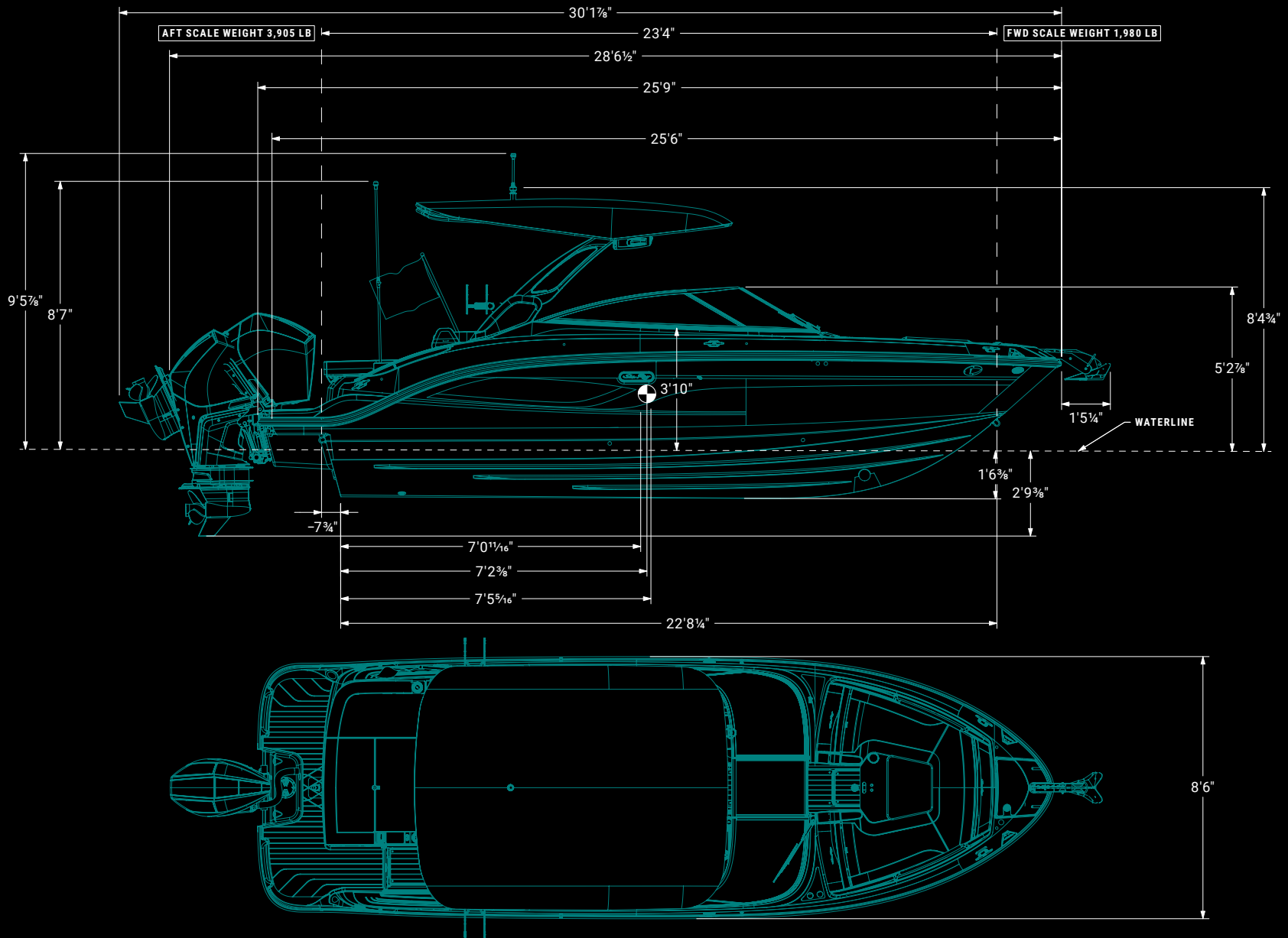



AT SEA RAY, WE BELIEVE THAT RICHER MOMENTS ON THE
WATER LEAD TO A RICHER LIFE. THAT'S WHY EVERYTHING
WE DO IS DESIGNED TO MAKE EACH MOMENT EXCEPTIONAL.

05112022

© 2022 Sea Ray Boats | 800 South Gay Street, Suite 1500, Knoxville, TN 37929 | searay.com

Features, options and specifications are subject to change and may vary for different model years. Some accessories may not be available (a) as standard features or upgradeable options, or (b) when a boat is built for regions outside of North America and/or has CE certification. Confirm specifications and availability of features and options with an authorized Sea Ray dealer.

